



**NATURAL
STONE BOX**

ISTRUZIONI DI MONTAGGIO

ASSEMBLY INSTRUCTIONS

BAUANLEITUNG

INSTRUCTIONS DE MONTAGE



ISTRUZIONI DI MONTAGGIO

ASSEMBLY INSTRUCTIONS / BAUANLEITUNG / INSTRUCTIONS DE MONTAGE

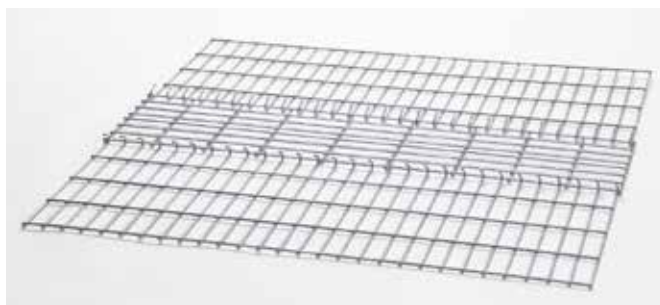

Posizionare la base incastrando i 2 laterali.
Place the base and line up the two short sides.
Stellen Sie die Grundfläche auf und verbinden Sie die zwei Seiten.
Placez la base en joignant les deux côtés longs.

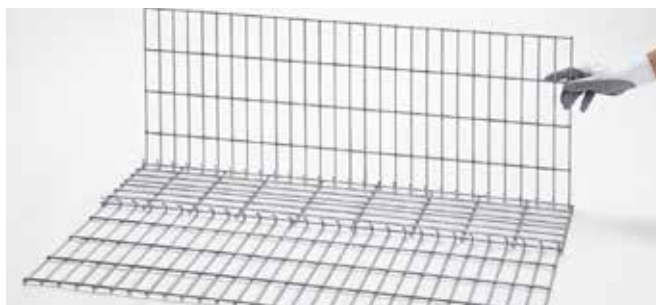

Sollevare i laterali lunghi.
Line up the long sides.
Nehmen Sie die Längsseiten.
Soulevez les côtés longs.



Chiudere gli angoli con una pinza.
Close all corners with a pair of pliers.
Schließen Sie die Ecken mit einer Zange.
Fermez les coins avec une paire de pinces.



Si può utilizzare un martello.
You can use a hammer.
Können Sie einen Hammer benutzen.
Vous pouvez utiliser un marteau.

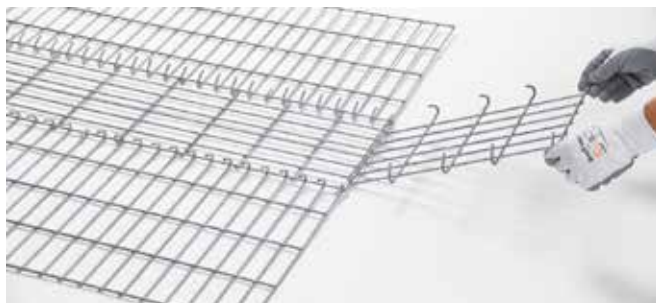

Sollevare i laterali corti e bloccarli con i laterali lunghi.
Stir up the short side and approach them to block with long sides.
Heben Sie die kurzen Seiten an und entsperren Sie so die Längsseite.
Soulevez les côtés courts en verrouiller avec les côtés longs.

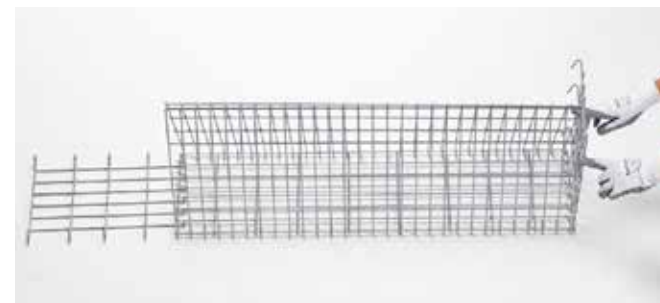

Sollevare i laterali lunghi.
Stir up the long sides.
Heben Sie die Längsseite an.
Soulevez les côtés longs.

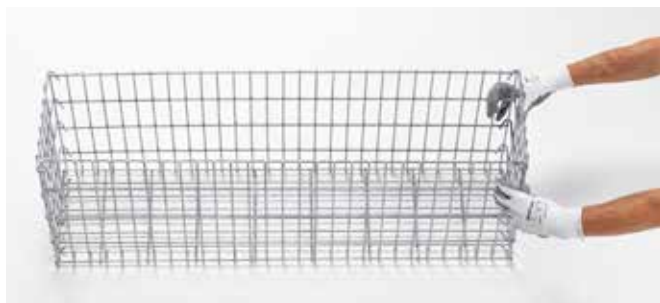

Incastrare i laterali lunghi con quelli corti.
Fix the long sides with the short ones.
Passen Sie die langen Seiten mit den kurzen Seiten an.
Montez les côtés longs avec les courts.



Chiudere gli angoli con una pinza, necessario solo il primo sopra.
Close the corners with a pair of pliers, if necessary only the first one up.
Schließen Sie die Ecken mit einer Zange, ggf. nur die erste.
Fermez les coins avec une paire de pinces, si nécessaire le premier seulement.



Posizionare i tiranti all'interno per evitare eventuali deformazioni del gabbione.
Place the rods inside to avoid any deformation of the gabion.
Platzieren Sie die zwei Stangen, um Verformungen der Gabionen zu vermeiden.
Placez les raidisseurs à l'intérieur pour éviter la déformation du gabion.



Posizionare il coperchio.
Place the top.
Legen Sie die Abdeckung auf.
Placez le couvercle.



Procedere con la chiusura del coperchio.
Proceed with the closing of the top.
Schließen Sie die Abdeckung.
Fermez le couvercle.



Gabbione Natural Stone Box montato.
Natural Stone Box gabion is assembled.
Gabionen Natural Stone Box ist montiert.
Le Natural Stone Box est monté.



Scegliere i ciottoli o granulati da inserire.
Choose the pebbles or granules to insert.
Wählen Sie die einzufügenden Kieselsteine oder Granulate.
Choisissez les cailloux ou les granules à insérer.



Riempire la gabbia fino all'orlo.
Fill the stonebox to the top.
Füllen Sie die Stonebox bis zum Rand.
Remplir la cage à ras bord.



Chiudere il coperchio.
Close with the top.
Schließen Sie die Abdeckung.
Fermez avec le couvercle.



Stringere bene i ganci con una pinza.
Tighten the hooks with pliers.
Ziehen Sie die Haken mit einer Zange an.
Serrez les crochets avec une pince.



Stringere bene i ganci con una pinza.
Tighten the hooks with pliers.
Ziehen Sie die Haken mit einer Zange an.
Serrez les crochets avec une pince.



Gabbione Natural Stone Box montato.
Natural Stone Box gabion is assembled.
Gabionen Natural Stone Box ist montiert.
Le Natural Stone Box est monté.

MATERIALE E ISTRUZIONI POSIZIONAMENTO TIRANTI

MATERIAL AND INSTRUCTIONS POSITIONING TIES

MATERIAL UND ANWEISUNGEN POSITIONIEREN VON KRAWATTEN

MATÉRIEL ET INSTRUCTIONS POSITIONNEMENT DES LIENS

TIPO 1

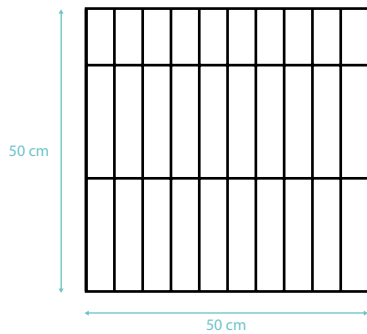
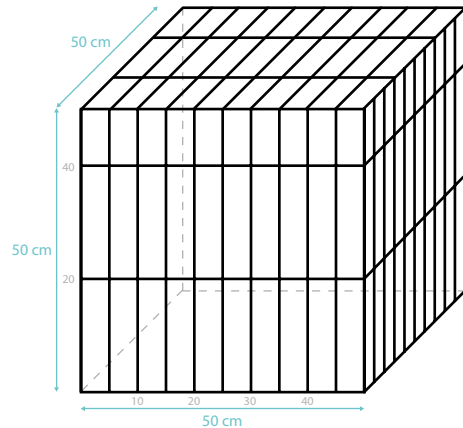

1 COPERCHIO e 1 BASE 50x50 cm 4 LATERALI 50x50 cm

- 1 TOP and 1 BASE 50x50 cm
- 4 SIDES 50x50 cm
- 1 TOP und 1 BASE 50x50 cm
- 4 SEITE 50x50 cm
- 1 TOP et 1 BASE 50x50 cm
- 4 CÔTÉ 50x50 cm

TIPO 2

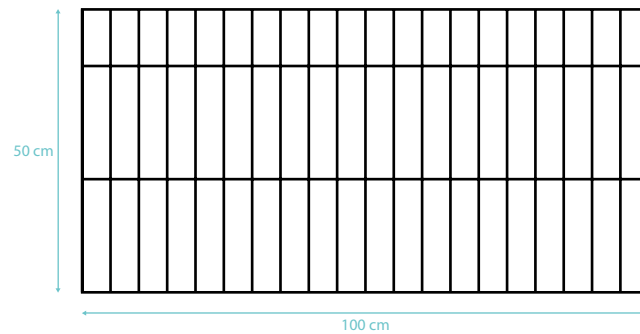
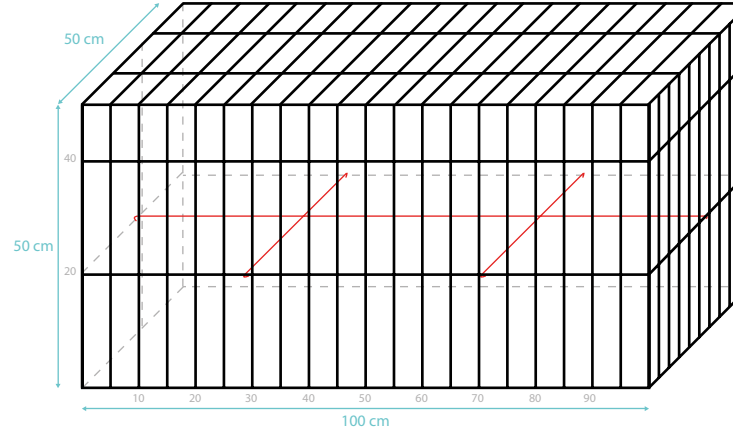

1 COPERCHIO e 1 BASE 100x50 cm 2 "LATERALE LUNGO" 100x50 cm

- 1 TOP and 1 BASE 100x50 cm
- 2 "LONG SIDE" 100x50 cm
- 1 TOP und 1 BASE 100x50 cm
- 2 "LANGE SEITE" 100x50 cm
- 1 TOP et 1 BASE 100x50 cm
- 2 "LONG CÔTÉ" 100x50 cm

- 2 "TIRANTE CORTO" 50 cm
- 1 "TIRANTE LUNGO" 100 cm
- 2 "SHORT TIES" 50 cm
- 1 "LONG TIES" 100 cm
- 2 "LANGE BINDUNGEN" 50 cm
- 1 "KURZE BINDUNGEN" 100 cm
- 2 "RAIDISSEURS LONGUES" 50 cm
- 1 "RAIDISSEURS COURTS" 100 cm

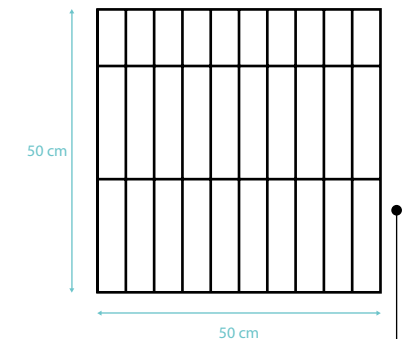

- ### 2 "LATERALE CORTO" 50x50 cm
- 2 "SHORT SIDE" 50x50 cm
 - 2 "KURZE SEITE" 50x50 cm
 - 2 "CÔTÉ COURT" 50x50 cm

TIPO 3

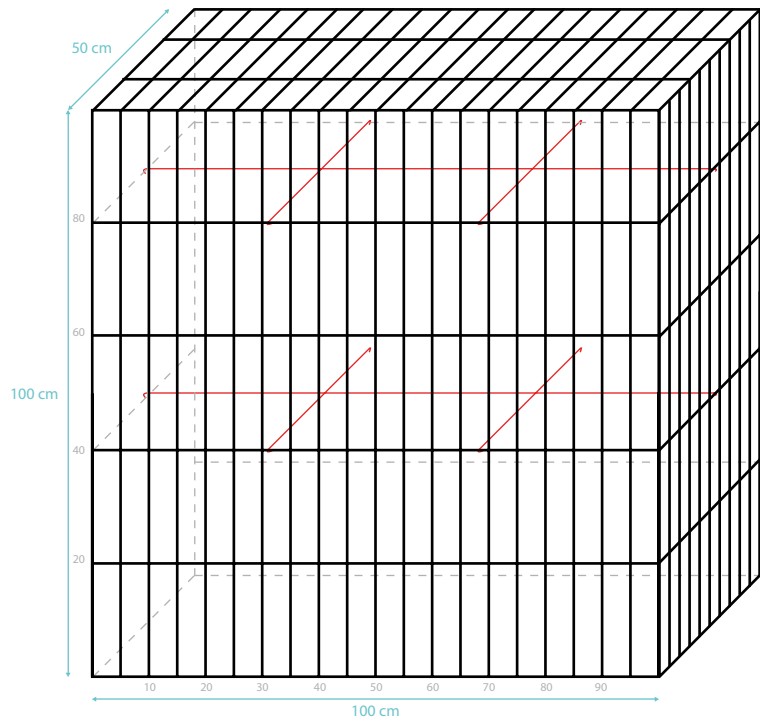

- 4 "TIRANTE CORTO" 50 cm**
- 2 "TIRANTE LUNGO" 100 cm**
- 4 "SHORT TIES" 50 cm
- 2 "LONG TIES" 100 cm
- 4 "LANGE BINDUNGEN" 50 cm
- 2 "KURZE BINDUNGEN" 100 cm
- 4 "RAIDISSEURS LONGUES" 50 cm
- 2 "RAIDISSEURS COURTS" 100 cm

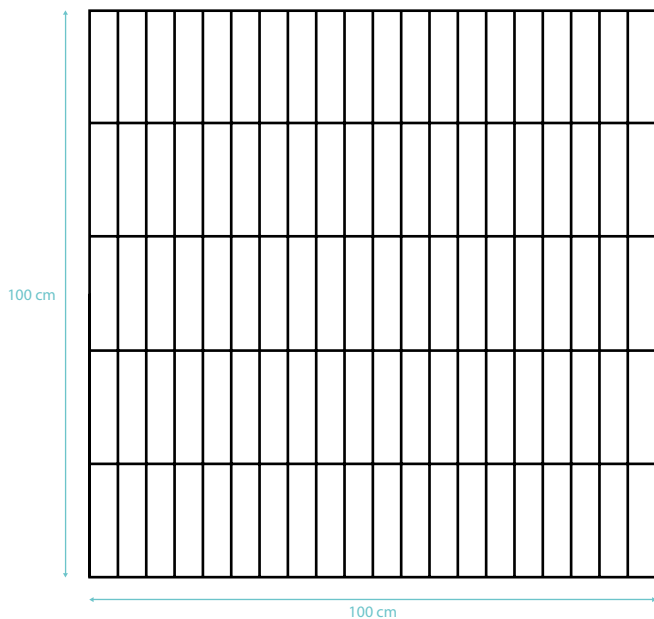

- 2 "LATERALE LUNGO" 100x100 cm**
- 2 "LONG SIDE" 100x100 cm
- 2 "LANGE SEITE" 100x100 cm
- 2 "LONG CÔTÉ" 100x100 cm

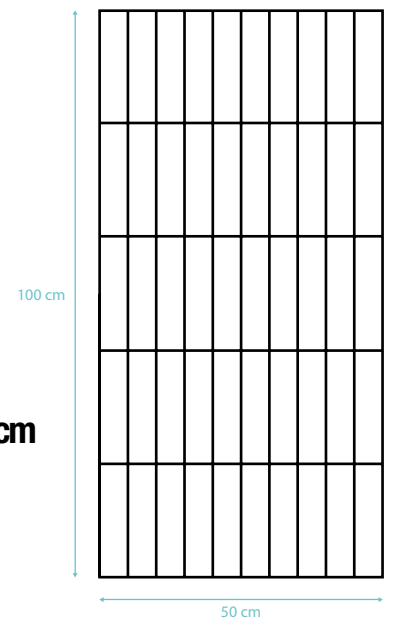

- 1 COPERCHIO e 1 BASE 100x50 cm**
- 2 "LATERALE CORTO" 50x100 cm**
- 1 TOP and 1 BASE 100x50 cm
- 2 "SHORT SIDE" 50x100 cm
- 1 TOP und 1 BASE 100x50 cm
- 2 "KURZE SEITE" 50x100 cm
- 1 TOP et 1 BASE 100x50 cm
- 2 "CÔTÉ COURT" 50x100 cm

TIPO 4

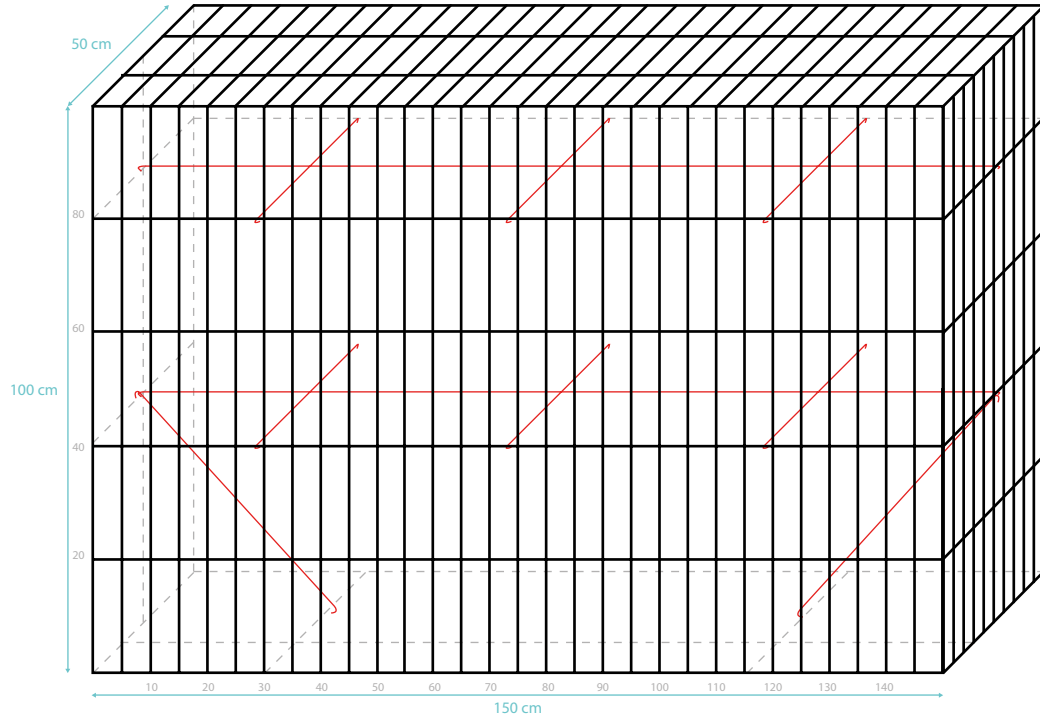

2 "LATERALE LUNGO" 150x100 cm

- 2 "LONG SIDE" 150x100 cm
- 2 "LANGE SEITE" 150x100 cm
- 2 "LONG CÔTÉ" 150x100 cm

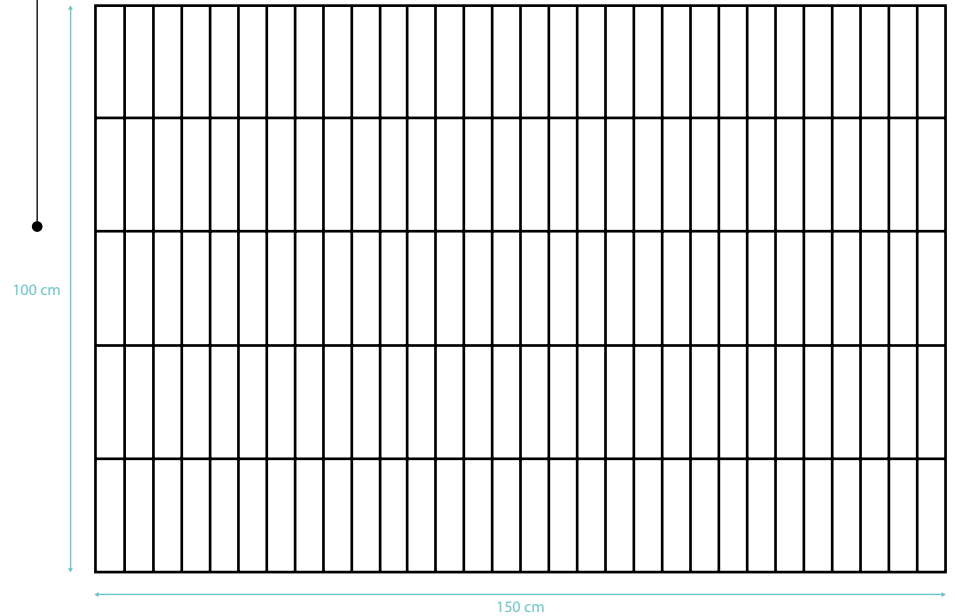

1 COPERCHIO e 1 BASE 150x50 cm

- 1 TOP and 1 BASE 150x50 cm
- 1 TOP und 1 BASE 150x50 cm
- 1 TOP et 1 BASE 150x50 cm

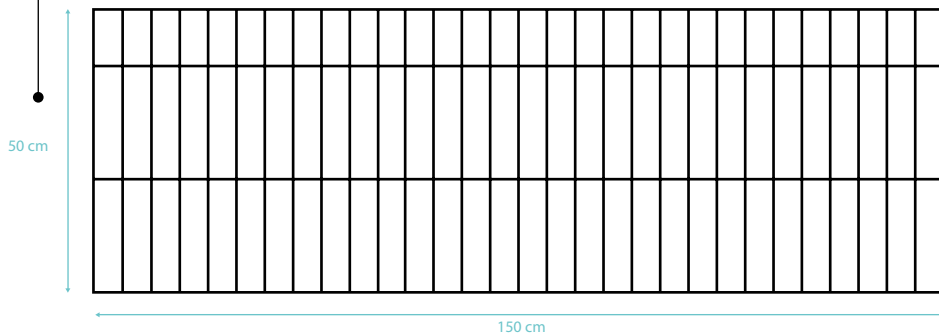

2 "LATERALE CORTO" 50x100 cm

- 2 "SHORT SIDE" 50x100 cm
- 2 "KURZE SEITE" 50x100 cm
- 2 "CÔTÉ COURT" 50x100 cm

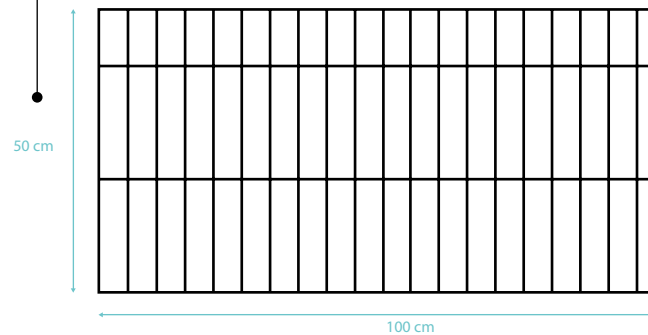

6 "TIRANTE CORTO" 50 cm

2 "TIRANTE LUNGO" 150 cm

2 "TIRANTE OBLIQUO" 50 cm

- 6 "SHORT TIES" 50 cm
- 2 "LONG TIES" 150 cm
- 2 "OBLIQUE TIES" 50 cm
- 6 "LANGE BINDUNGEN" 50 cm
- 2 "KURZE BINDUNGEN" 150 cm
- 2 "OBLIQUE BINDUNGEN" 50 cm
- 6 "RAIDISSEURS LONGUES" 50 cm
- 2 "RAIDISSEURS COURTS" 150 cm
- 2 "RAIDISSEURS OBLIQUE" 50 cm

TIPO 5

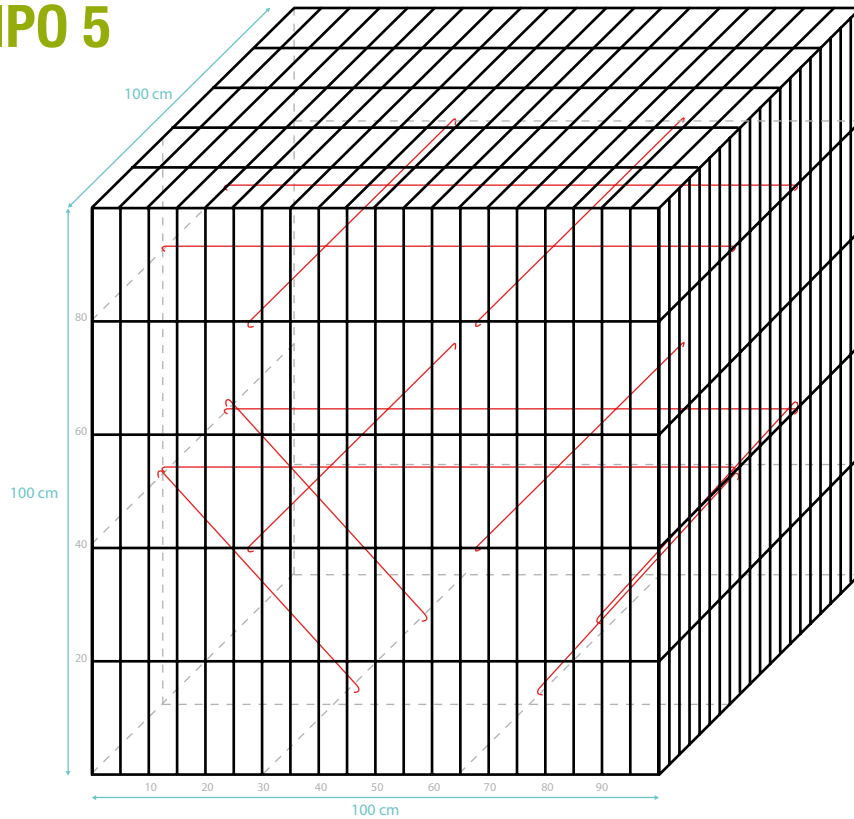

8 "TIRANTE LUNGO" 100 cm

4 "TIRANTE OBLIQUO" 50 cm

8 "LONG TIES" 100 cm

4 "OBLIQUE TIES" 50 cm

8 "LANGE BINDUNGEN" 100 cm

4 "OBLIQUE BINDUNGEN" 50 cm

8 "RAIDISSEURS LONGUES" 100 cm

4 "RAIDISSEURS OBLIQUE" 50 cm

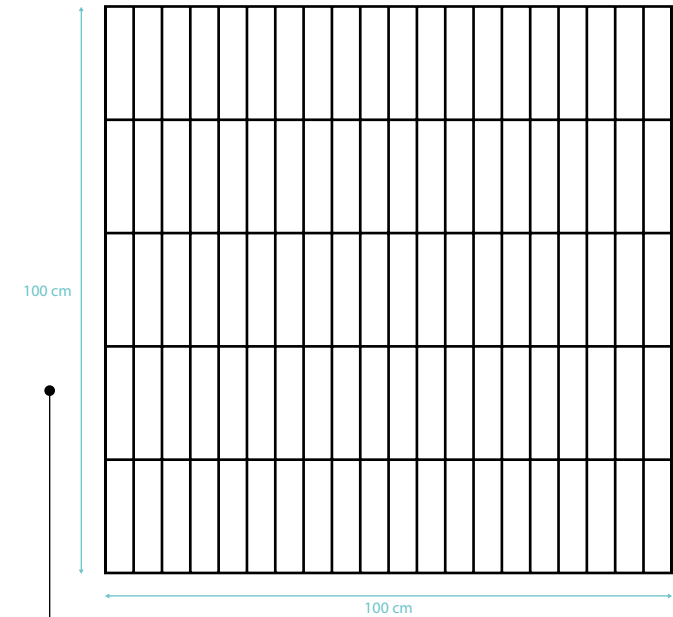

1 COPERCHIO e 1 BASE 100x100 cm

4 LATERALI 100x100 cm

1 TOP and 1 BASE 100x100 cm

4 SIDES 100x100 cm

1 TOP und 1 BASE 100x100 cm

4 SEITE 100x100 cm

1 TOP et 1 BASE 100x100 cm

4 MURS 100x100 cm

TIPO 6

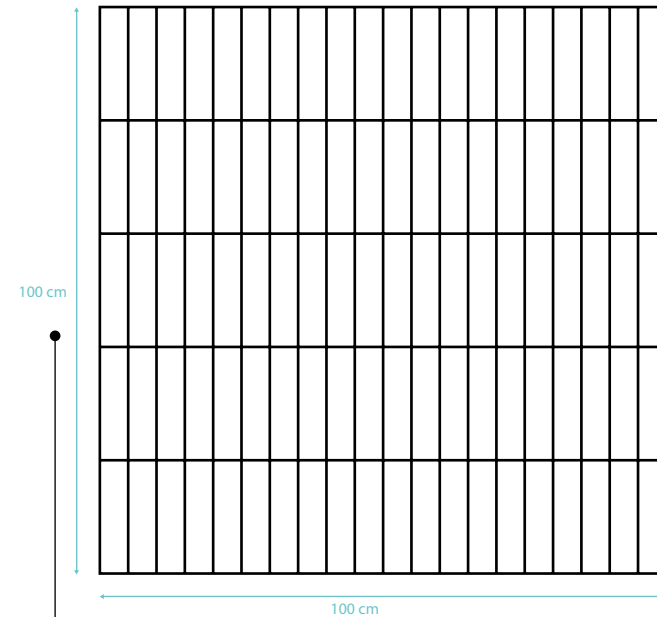
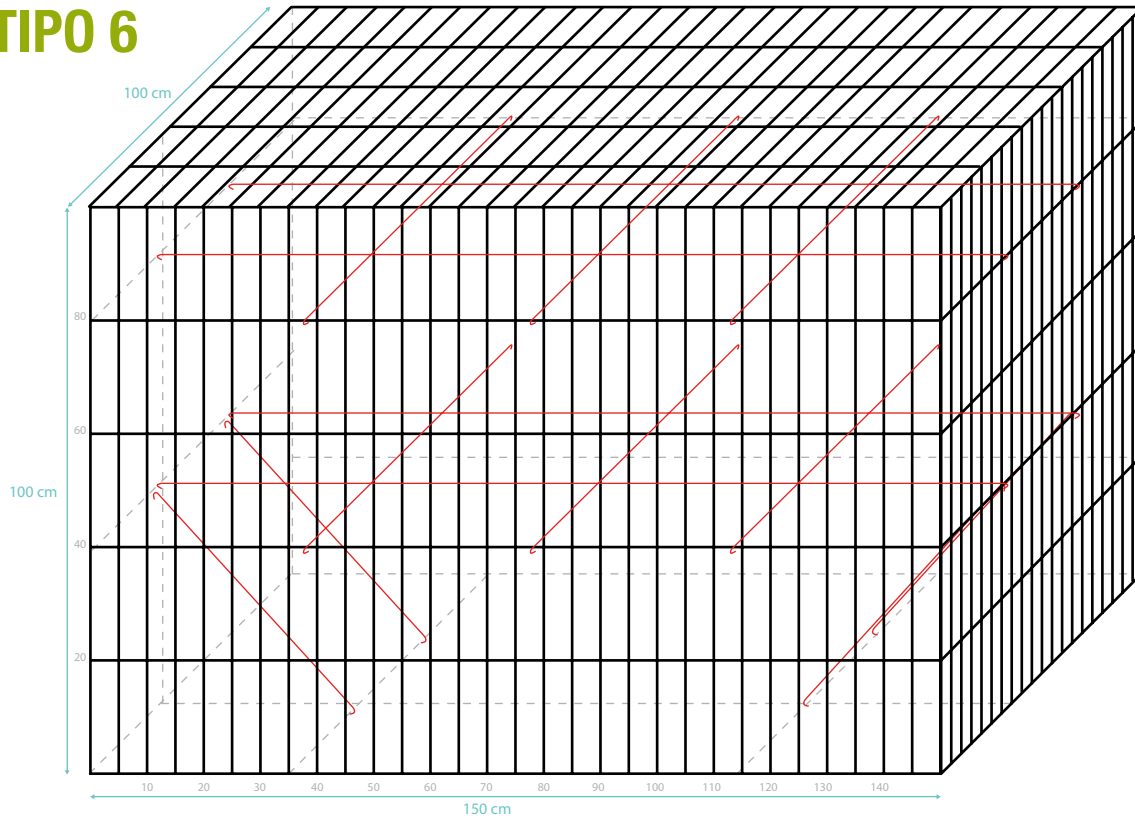

2 "LATERALE CORTO" 100x100 cm

- 2 "SHORT SIDE" 100x100 cm
- 2 "KURZE SEITE" 100x100 cm
- 2 "CÔTÉ COURT" 100x100 cm

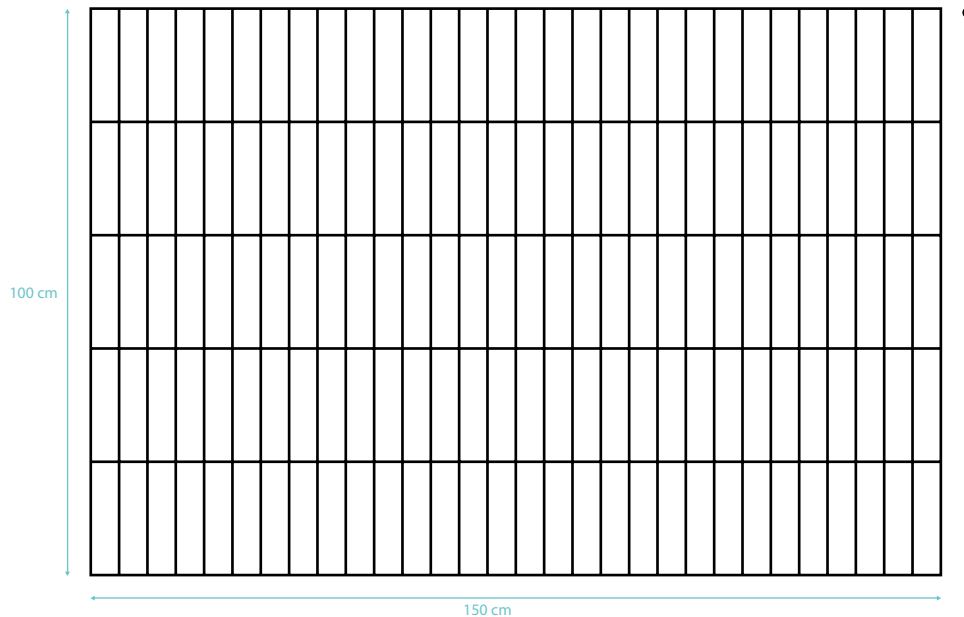

1 COPERCHIO

e 1 BASE 150x100 cm

2 "LATERALE LUNGO" 150x100 cm

- 1 TOP and 1 BASE 150x100 cm
- 2 "LONG SIDE" 150x100 cm
- 1 TOP und 1 BASE 150x100 cm
- 2 "LANGE SEITE" 150x100 cm
- 1 TOP et 1 BASE 150x100 cm
- 2 "LONG CÔTÉ" 150x100 cm

6 "TIRANTE CORTO" 100 cm

4 "TIRANTE LUNGO" 150 cm

4 "TIRANTE OBLIQUO" 50 cm

- 6 "SHORT TIES" 100 cm
- 4 "LONG TIES" 150 cm
- 4 "OBLIQUE TIES" 50 cm
- 6 "LANGE BINDUNGEN" 100 cm
- 4 "KURZE BINDUNGEN" 150 cm
- 4 "OBLIQUE BINDUNGEN" 50 cm
- 6 "RAIDISSEURS LONGUES" 100 cm
- 4 "RAIDISSEURS COURTS" 150 cm
- 4 "RAIDISSEURS OBLIQUE" 50 cm

TIPO 7

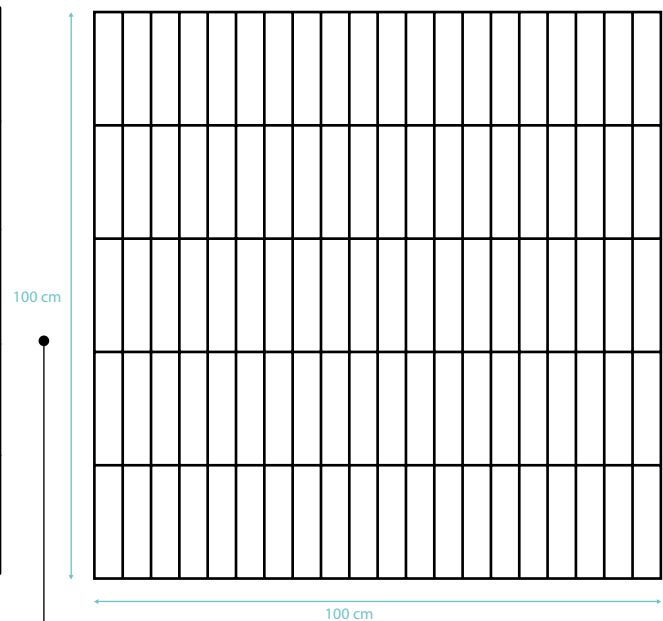
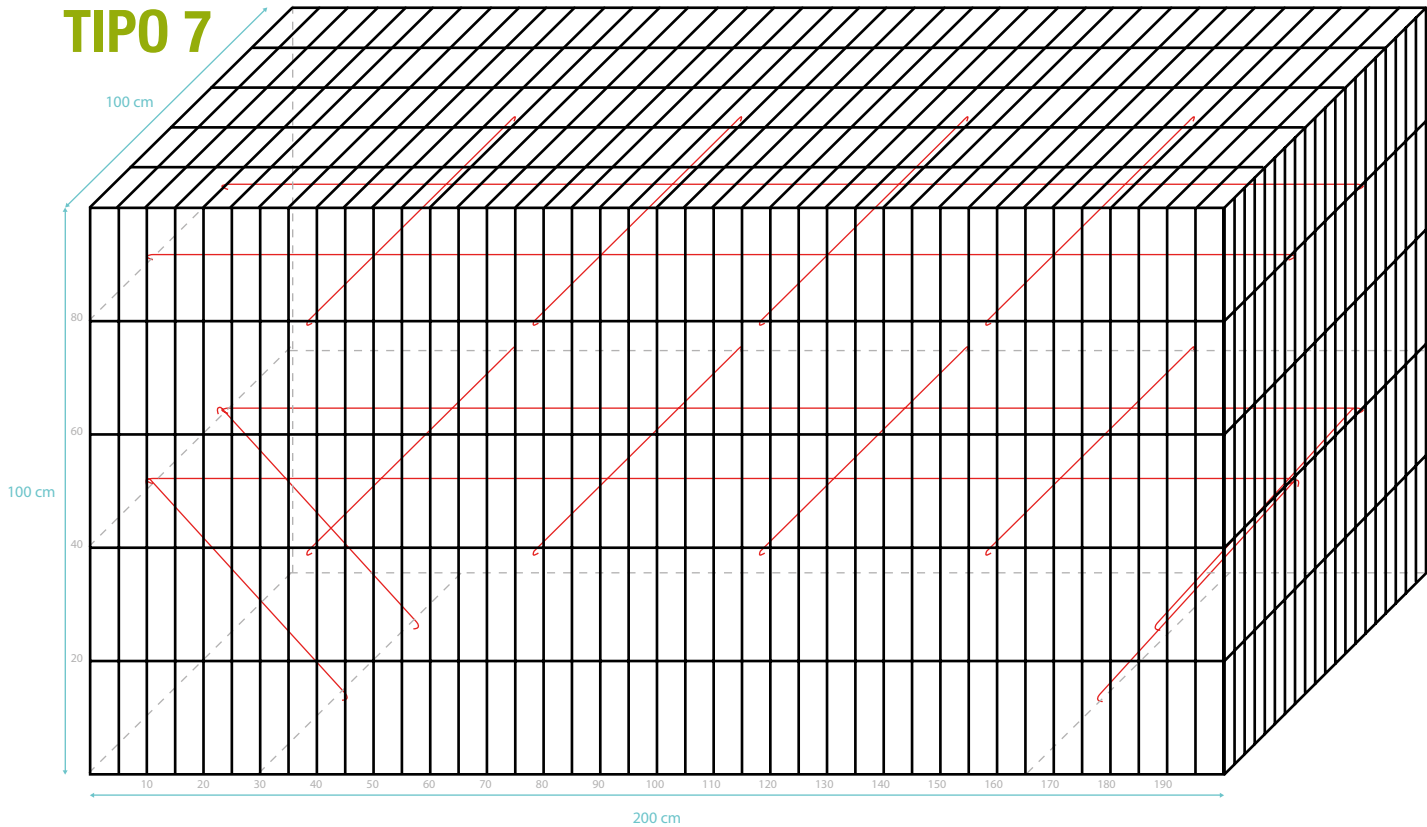

- 2 "LATERALE CORTO" 100x100 cm**
- 2 "SHORT SIDE" 100x100 cm
- 2 "KURZE SEITE" 100x100 cm
- 2 "CÔTÉ COURT" 100x100 cm

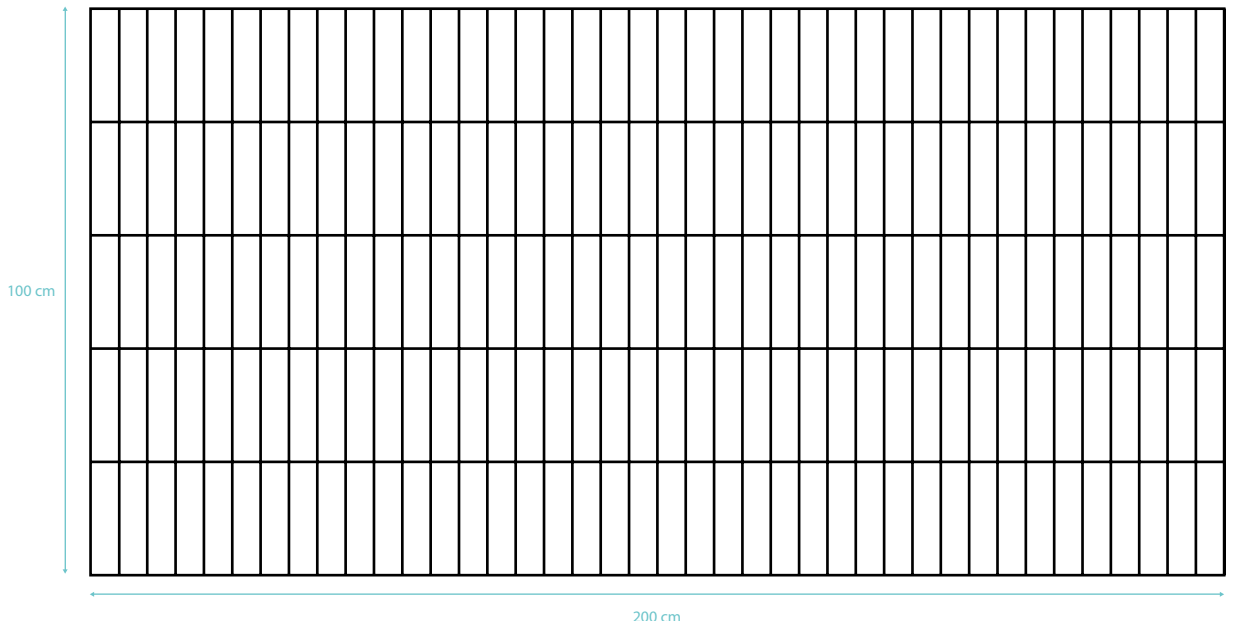

- 1 COPERCHIO**
- e 1 BASE 200x100 cm**
- 2 "LATERALE LUNGO" 200x100 cm**
- 1 TOP and 1 BASE 200x100 cm
- 2 "LONG SIDE" 200x100 cm
- 1 TOP und 1 BASE 200x100 cm
- 2 "LANGE SEITE" 200x100 cm
- 1 TOP et 1 BASE 200x100 cm
- 2 "LONG CÔTÉ" 200x100 cm

- 8 "TIRANTE CORTO" 100 cm**
- 4 "TIRANTE LUNGO" 200 cm**
- 4 "TIRANTE OBLIQUO" 50 cm**
- 8 "SHORT TIES" 100 cm
- 4 "LONG TIES" 200 cm
- 4 "OBLIQUE TIES" 50 cm
- 8 "LANGE B." 100 cm
- 4 "KURZE B." 200 cm
- 4 "OBLIQUE B." 50 cm
- 8 "R. LONGUES" 100 cm
- 4 "R. COURTS" 200 cm
- 4 "R. OBLIQUE" 50 cm

TIPO 8

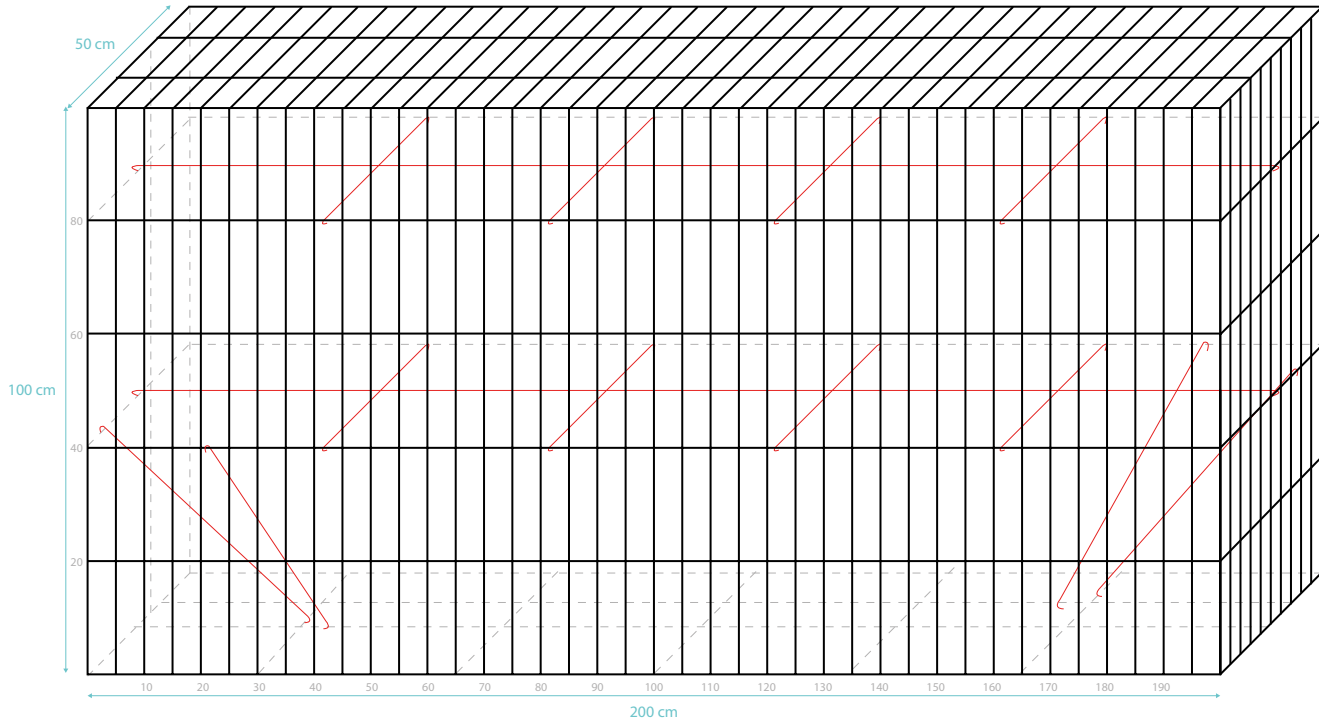

2 "LATERALE LUNGO" 200x100 cm
 2 "LONG SIDE" 200x100 cm

2 "LANGE SEITE" 200x100 cm
 2 "LONG CÔTÉ" 200x100 cm

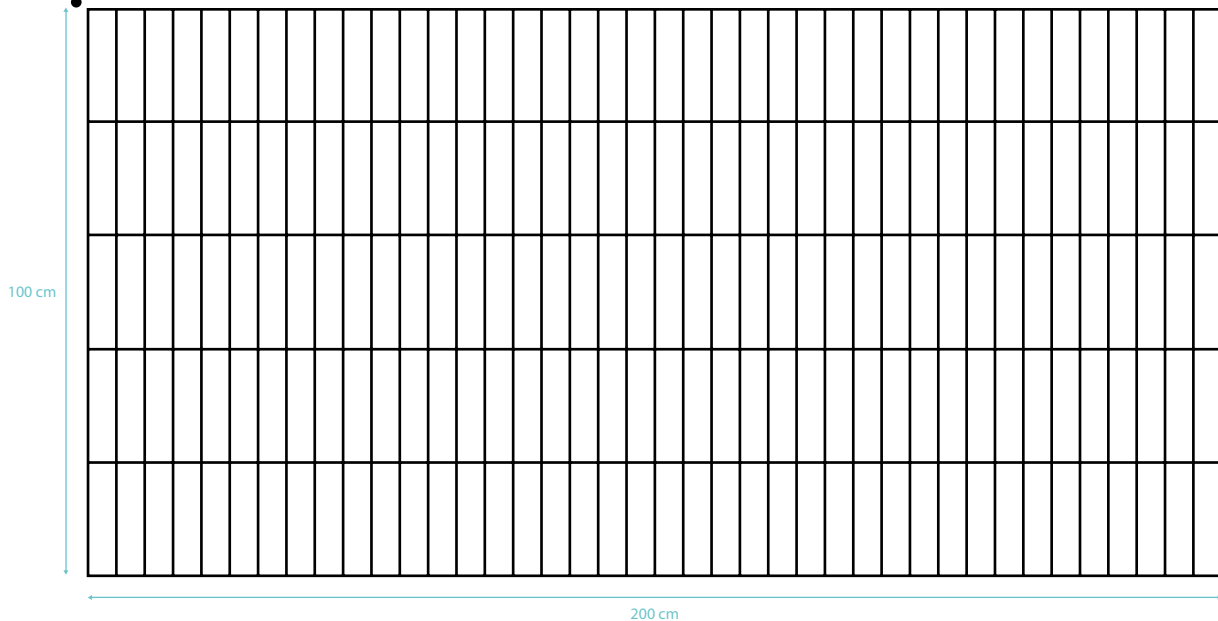

1 COPERCHIO

e 1 BASE 200x50 cm

1 TOP, 1 BASE 200x50 cm

1 TOP, 1 BASE 200x50 cm

1 TOP, 1 BASE 200x50 cm

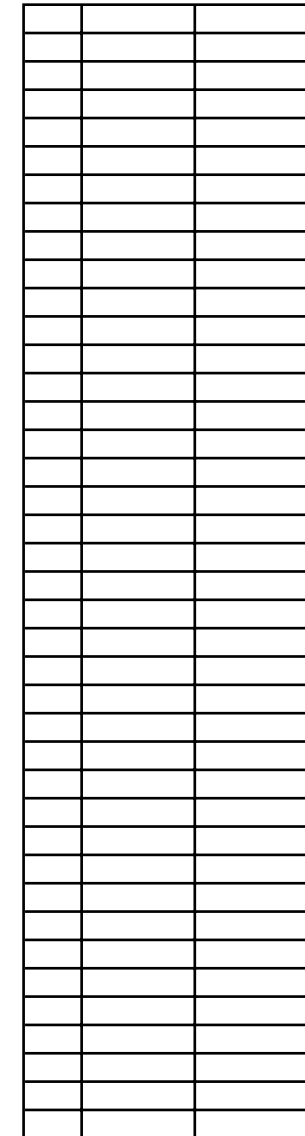

8 "TIRANTE CORTO" 50 cm

2 "TIRANTE LUNGO" 200 cm

4 "TIRANTE OBLIQUO" 50 cm

8 "SHORT TIES" 50 cm

2 "LONG TIES" 200 cm

4 "OBLIQUE TIES" 50 cm

8 "LANGE B." 50 cm

2 "KURZE B." 200 cm

4 "OBLIQUE B." 50 cm

8 "R. LONGUES" 50 cm

2 "R. COURTS" 200 cm

4 "R. OBLIQUE" 50 cm

2 "LATERALE CORTO"

50x100 cm

2 "SHORT SIDE" 50x100 cm

2 "KURZE SEITE" 50x100 cm

2 "CÔTÉ COURT" 50x100 cm

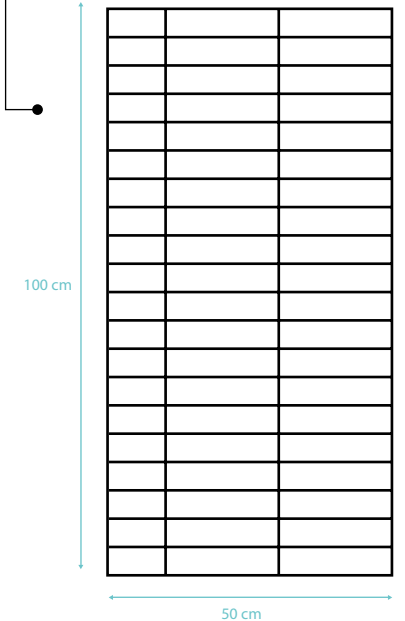

TIPO 9

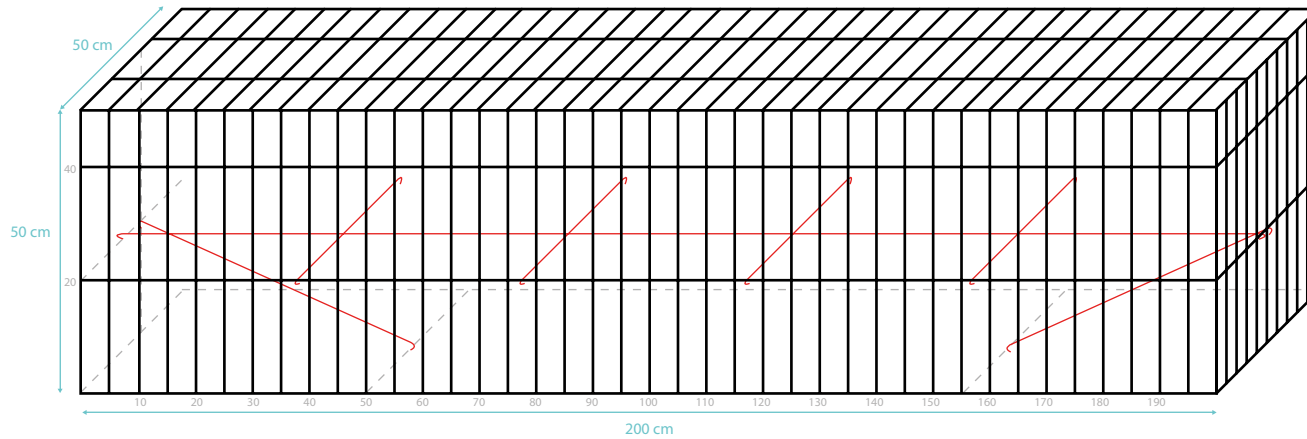

- 4 "TIRANTE CORTO" 50 cm
- 1 "TIRANTE LUNGO" 200 cm
- 2 "TIRANTE OBLIQUO" 50 cm
- 4 "SHORT TIES" 50 cm
- 1 "LONG TIES" 200 cm
- 2 "OBLIQUE TIES" 50 cm
- 4 "LANGE B." 50 cm
- 1 "KURZE B." 200 cm
- 2 "OBLIQUE B." 50 cm
- 4 "R. LONGUES" 50 cm
- 1 "R. COURTS" 200 cm
- 2 "R. OBLIQUE" 50 cm

1 COPERCHIO e 1 BASE 200x50 cm

2 "LATERALE LUNGO" 200x50 cm

- 1 TOP and 1 BASE 200x50 cm
- 2 "LONG SIDE" 200x50 cm
- 1 TOP und 1 BASE 200x50 cm
- 2 "LANGE SEITE" 200x50 cm
- 1 TOP et 1 BASE 200x50 cm
- 2 "LONG CÔTÉ" 200x50 cm

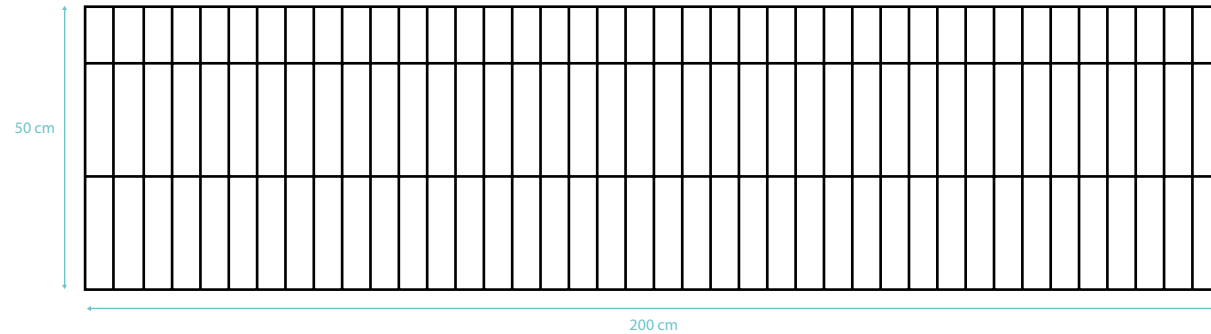

2 "LATERALE CORTO" 50x50 cm

- 2 "SHORT SIDE" 50x50 cm
- 2 "KURZE SEITE" 50x50 cm
- 2 "CÔTÉ COURT" 50x50 cm

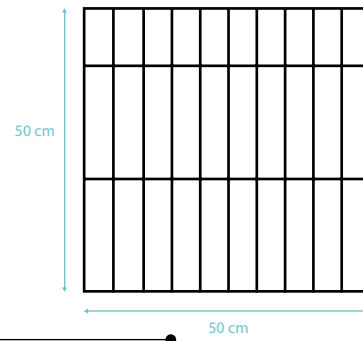

TIPO 10

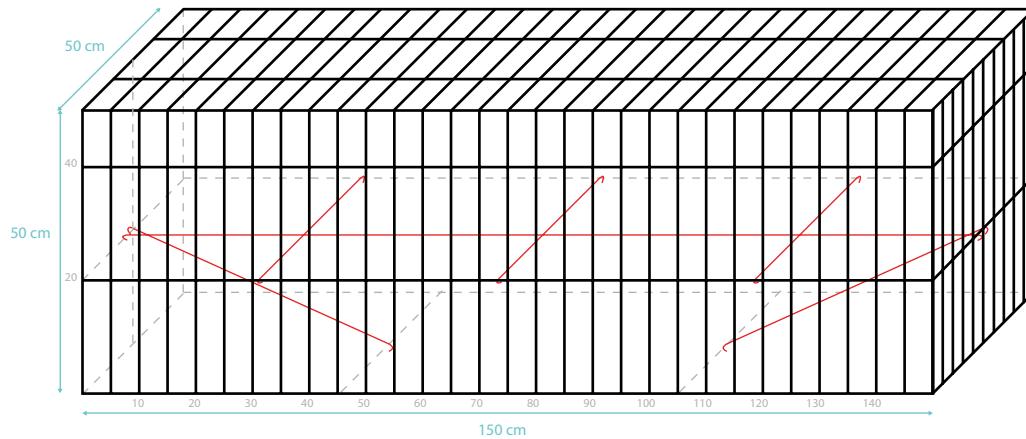

1 COPERCHIO e 1 BASE 150x50 cm

2 "LATERALE LUNGO" 150x50 cm

- 1 TOP and 1 BASE 150x50 cm
- 2 "LONG SIDE" 150x50 cm
- 1 TOP und 1 BASE 150x50 cm
- 2 "LANGE SEITE" 150x50 cm
- 1 TOP et 1 BASE 150x50 cm
- 2 "LONG CÔTÉ" 150x50 cm

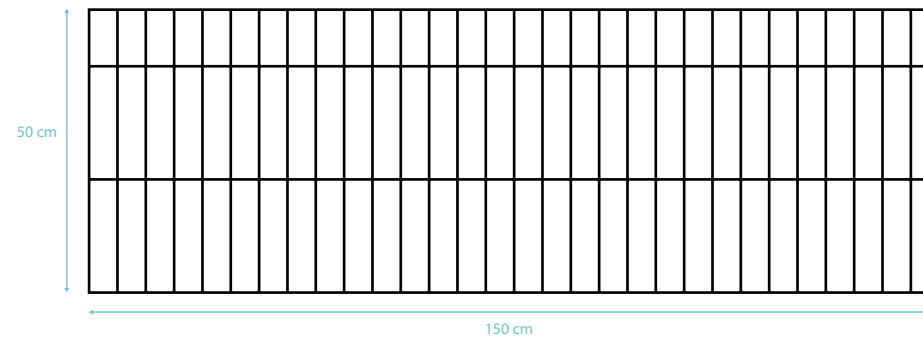

2 "LATERALE CORTO" 50x50 cm

- 2 "SHORT SIDE" 50x50 cm
- 2 "KURZE SEITE" 50x50 cm
- 2 "CÔTÉ COURT" 50x50 cm

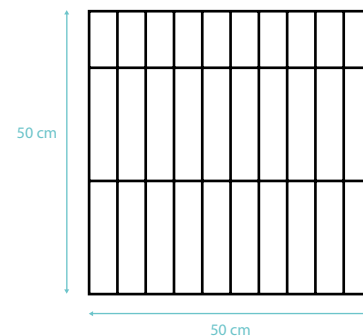

- 3 "TIRANTE CORTO" 50 cm
- 1 "TIRANTE LUNGO" 150 cm
- 2 "TIRANTE OBLIQUO" 50 cm
- 3 "SHORT TIES" 50 cm
- 1 "LONG TIES" 150 cm
- 2 "OBLIQUE TIES" 50 cm
- 3 "LANGE BINDUNGEN" 50 cm
- 1 "KURZE BINDUNGEN" 150 cm
- 2 "OBLIQUE BINDUNGEN" 50 cm
- 3 "R. LONGUES" 50 cm
- 1 "R. COURTS" 150 cm
- 2 "R. OBLIQUE" 50 cm

TIPO 11

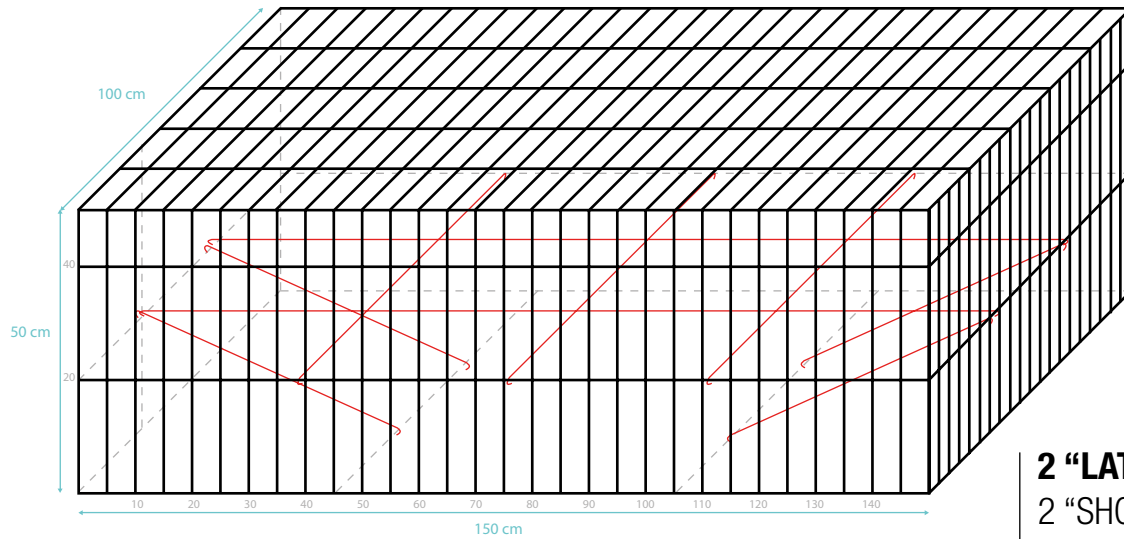

- 3 "TIRANTE CORTO" 100 cm**
- 2 "TIRANTE LUNGO" 150 cm**
- 4 "TIRANTE OBLIQUO" 50 cm**
- 3 "SHORT TIES" 100 cm
- 2 "LONG TIES" 150 cm
- 4 "OBLIQUE TIES" 50 cm
- 3 "LANGE BINDUNGEN" 100 cm
- 2 "KURZE BINDUNGEN" 150 cm
- 4 "OBLIQUE BINDUNGEN" 50 cm
- 3 "RAIDISSEURS LONGUES" 100 cm
- 2 "RAIDISSEURS COURTS" 150 cm
- 4 "RAIDISSEURS OBLIQUE" 50 cm

1 COPERCHIO e 1 BASE 150x100 cm

- 1 TOP and 1 BASE 150x100 cm
- 1 TOP und 1 BASE 150x100 cm
- 1 TOP et 1 BASE 150x100 cm

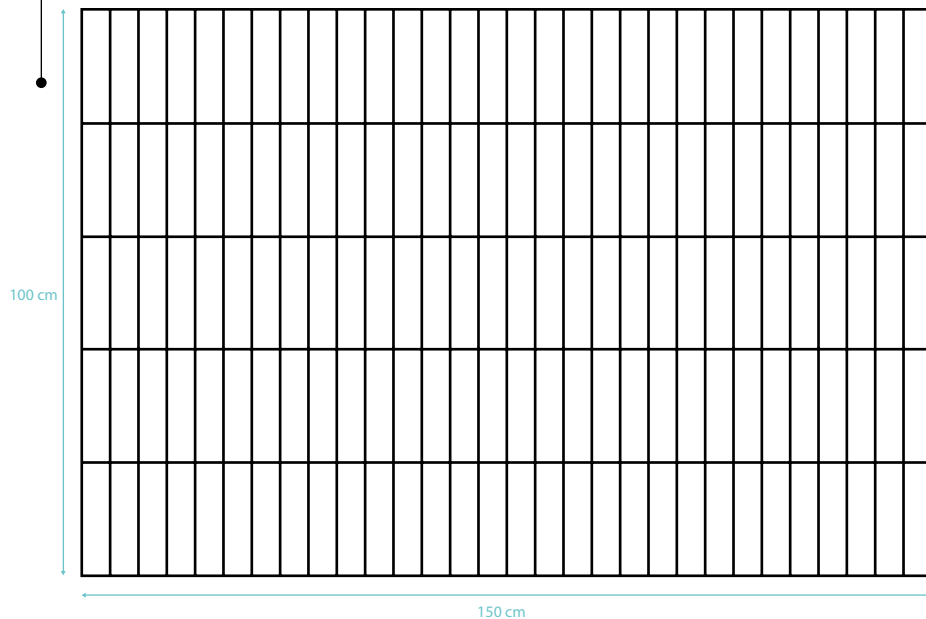

2 "LATERALE CORTO" 100x50 cm

- 2 "SHORT SIDE" 100x50 cm
- 2 "KURZE SEITE" 100x50 cm
- 2 "CÔTÉ COURT" 100x50 cm

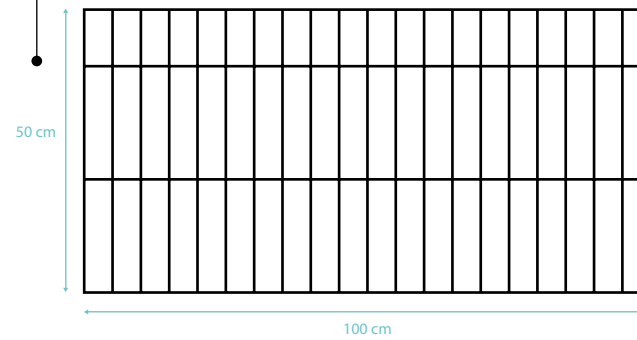

2 "LATERALE LUNGO" 150x50 cm

- 2 "LONG SIDE" 150x50 cm
- 2 "LANGE SEITE" 150x50 cm
- 2 "LONG CÔTÉ" 150x50 cm

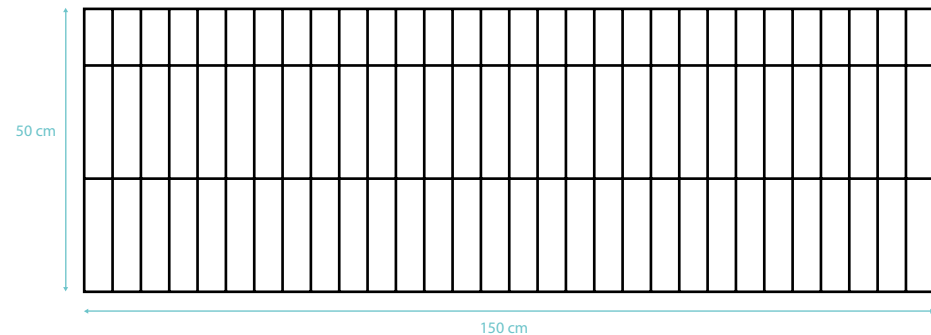

TIPO 12

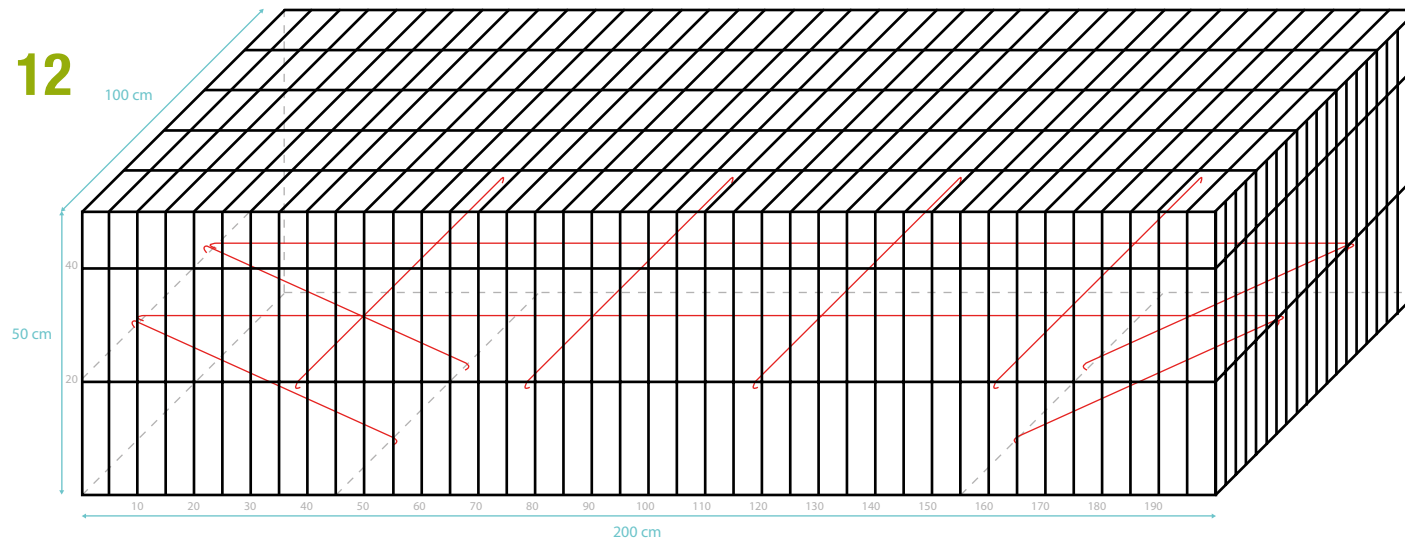

- 4 "TIRANTE CORTO" 100 cm**
- 2 "TIRANTE LUNGO" 200 cm**
- 4 "TIRANTE OBLIQUO" 50 cm**
- 4 "SHORT TIES" 100 cm
- 2 "LONG TIES" 200 cm
- 4 "OBLIQUE TIES" 50 cm
- 4 "LANGE B." 100 cm
- 2 "KURZE B." 200 cm
- 4 "OBLIQUE B." 50 cm
- 4 "R. LONGUES" 100 cm
- 2 "R. COURTS" 200 cm
- 4 "R. OBLIQUE" 50 cm

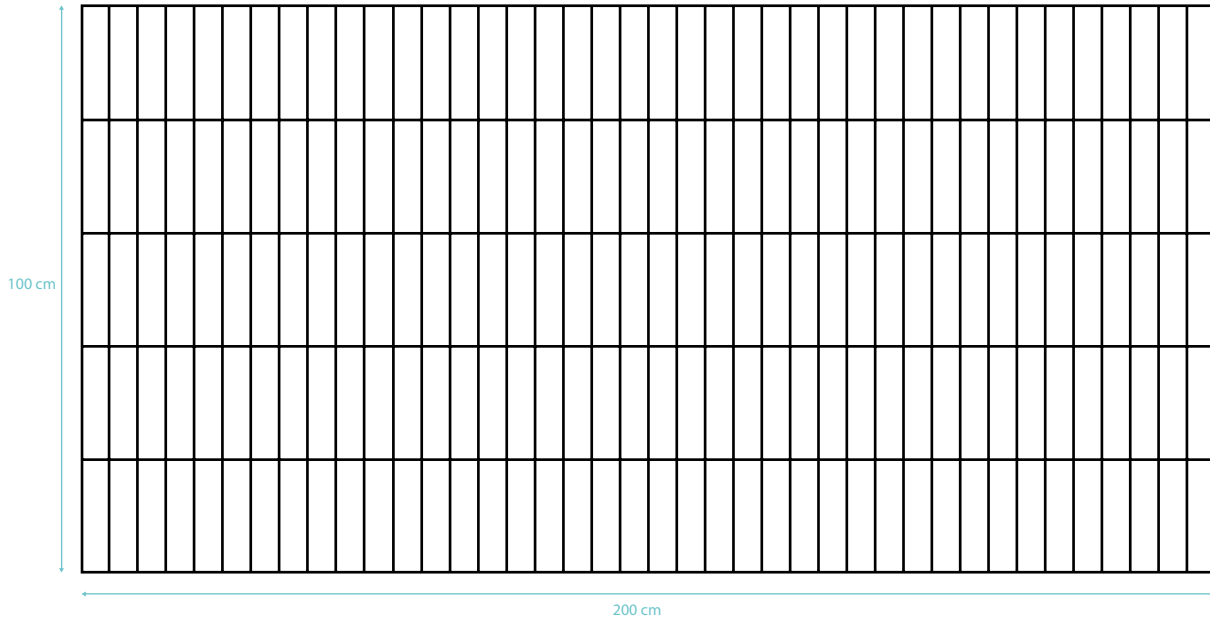

1 COPERCHIO e 1 BASE 200x100 cm

- 1 TOP and 1 BASE 200x100 cm
- 1 TOP und 1 BASE 200x100 cm
- 1 TOP et 1 BASE 200x100 cm

2 "LATERALE CORTO" 100x50 cm

- 2 "SHORT SIDE" 100x50 cm
- 2 "KURZE SEITE" 100x50 cm
- 2 "CÔTÉ COURT" 100x50 cm

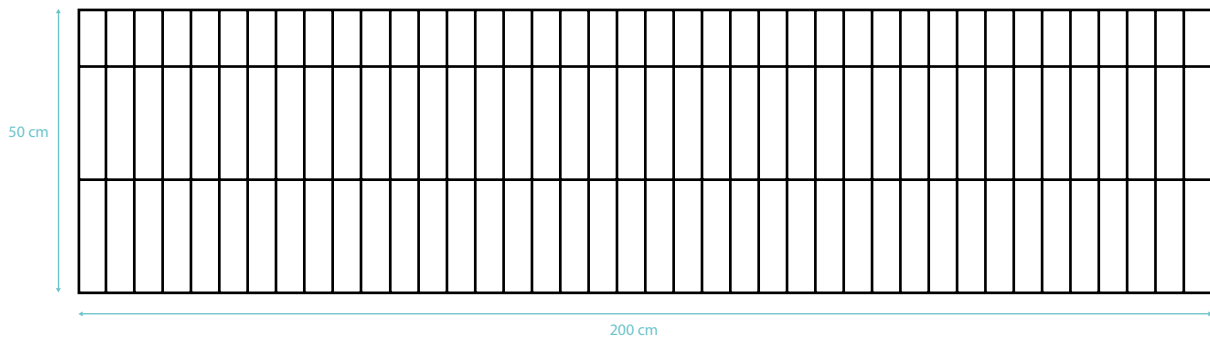
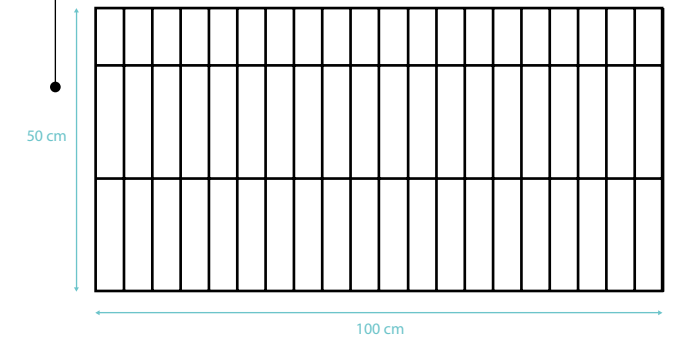

2 "LATERALE LUNGO" 200x50 cm

- 2 "LONG SIDE" 200x50 cm
- 2 "LANGE SEITE" 200x50 cm
- 2 "LONG CÔTÉ" 200x50 cm

TIPO 13

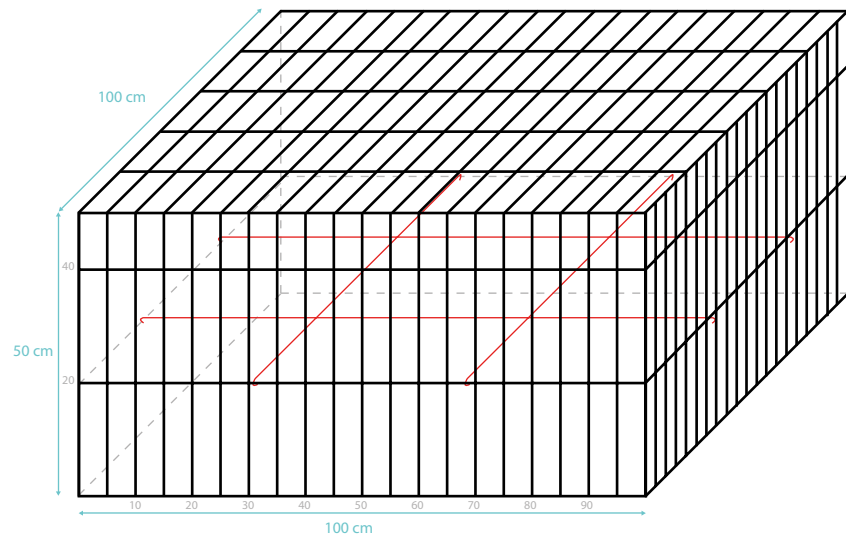

4 TIRANTI 100 cm

4 TIES 100 cm

4 BINDUNGEN 100 cm

4 RAIDISSEURS 100 cm

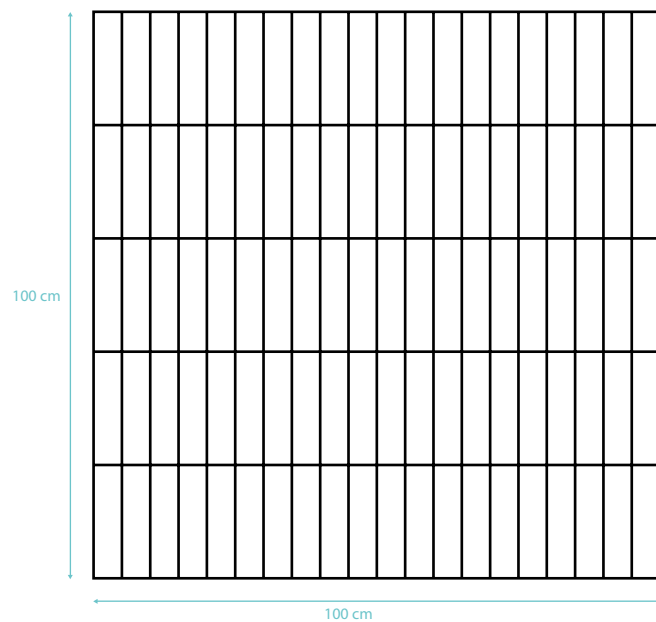

1 COPERCHIO e 1 BASE 100x100 cm

1 TOP and 1 BASE 100x100 cm

1 TOP und 1 BASE 100x100 cm

1 TOP et 1 BASE 100x100 cm

4 LATERALI 100x50 cm

4 SIDES 100x50 cm

4 SEITE 100x50 cm

4 CÔTÉ 100x50 cm

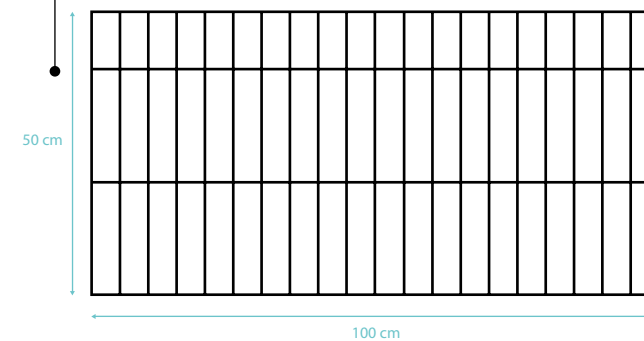

TIPO 14

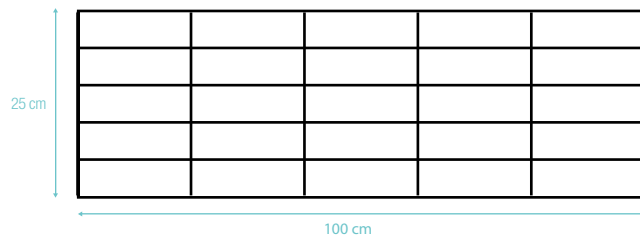
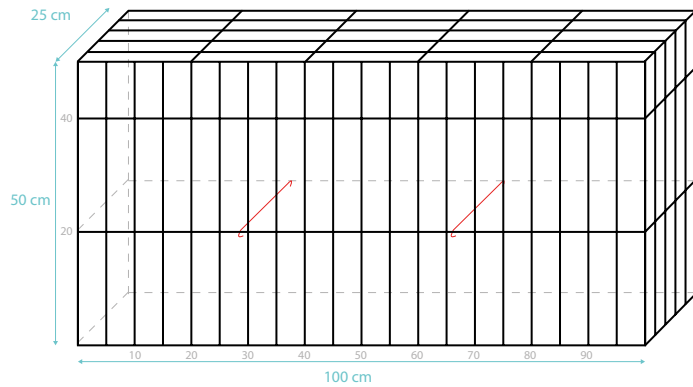

1 COPERCHIO e 1 BASE 100x25 cm

- 1 TOP and 1 BASE 100x25 cm
- 1 TOP und 1 BASE 100x25 cm
- 1 TOP et 1 BASE 100x25 cm

2 "TIRANTE CORTO" 25 cm

- 2 "SHORT TIES" 25 cm
- 2 "KURZE BINDUNGEN" 25 cm
- 2 "RAIDISSEURS COURTS" 25 cm

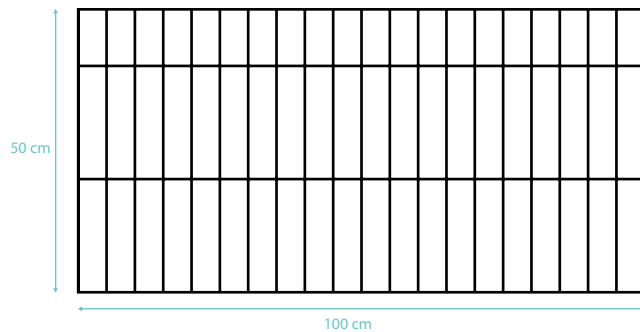

2 "LATERALE LUNGO" 100x50 cm

- 2 "LONG SIDE" 100x50 cm
- 2 "LANGE SEITE" 100x50 cm
- 2 "LONG CÔTÉ" 100x50 cm

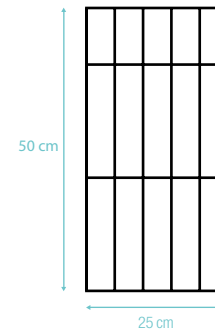

2 "LATERALE CORTO" 25x50 cm

- 2 "SHORT SIDE" 25x50 cm
- 2 "KURZE SEITE" 25x50 cm
- 2 "CÔTÉ COURT" 25x50 cm

TIPO 15

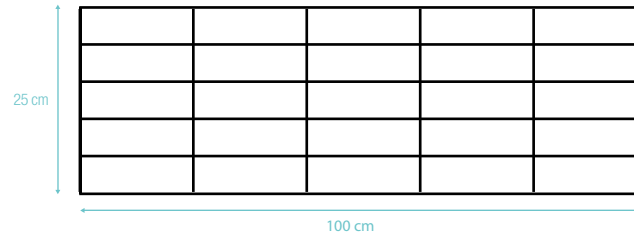
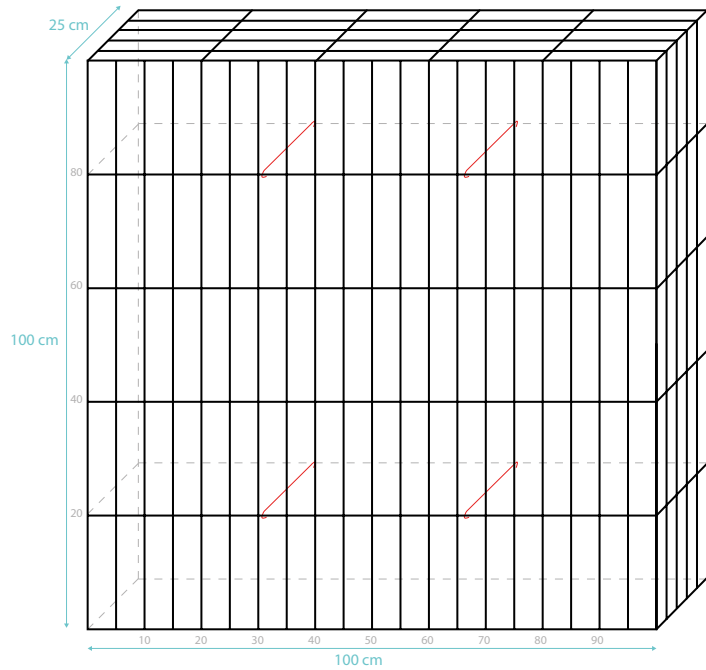

1 COPERCHIO e 1 BASE 100x25 cm

2 "LATERALE CORTO" 25x100 cm

1 TOP and 1 BASE 100x25 cm

2 "SHORT SIDE" 25x100 cm

1 TOP und 1 BASE 100x25 cm

2 "KURZE SEITE" 25x100 cm

1 TOP et 1 BASE 100x25 cm

2 "CÔTÉ COURT" 25x100 cm

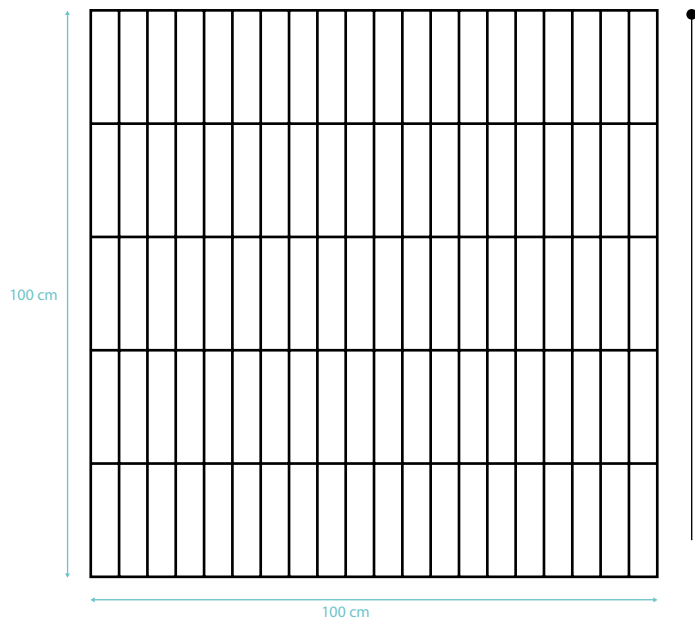

2 "LATERALE LUNGO" 100x100 cm

2 "LONG SIDE" 100x100 cm

2 "LANGE SEITE" 100x100 cm

2 "LONG CÔTÉ" 100x100 cm

4 "TIRANTE CORTO" 25 cm

4 "SHORT TIES" 25 cm

4 "KURZE BINDUNGEN" 25 cm

4 "RAIDISSEURS COURTS" 25 cm

TIPO 16

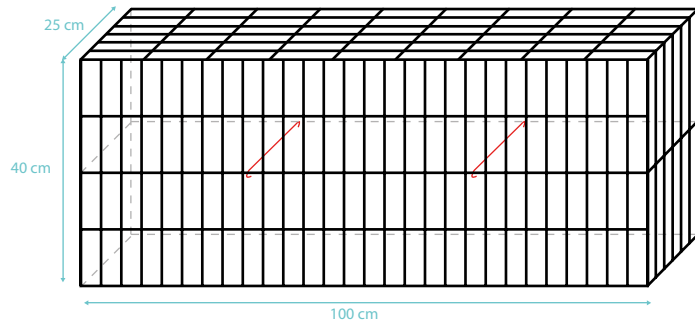

2 "TIRANTE CORTO" 25 cm

2 "SHORT TIES" 25 cm

2 "KURZE BINDUNGEN" 25 cm

2 "RAIDISSEURS COURTS" 25 cm

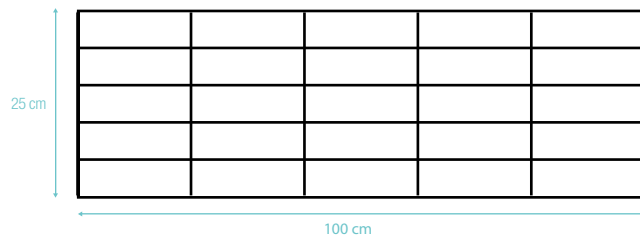

1 COPERCHIO e 1 BASE 100x25 cm

1 TOP and 1 BASE 100x25 cm

1 TOP und 1 BASE 100x25 cm

1 TOP et 1 BASE 100x25 cm

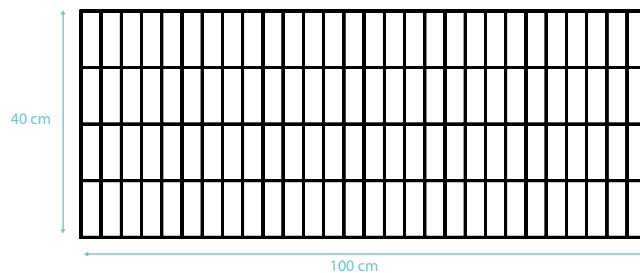

2 "LATERALE LUNGO" 100x40 cm

2 "LONG SIDE" 100x40 cm

2 "LANGE SEITE" 100x40 cm

2 "LONG CÔTÉ" 100x40 cm

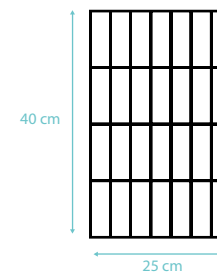

2 "LATERALE CORTO" 25x40 cm

2 "SHORT SIDE" 25x40 cm

2 "KURZE SEITE" 25x40 cm

2 "CÔTÉ COURT" 25x40 cm

AVVERTENZE

WARNINGS / WARNHINWEISE / AVERTISSEMENTS

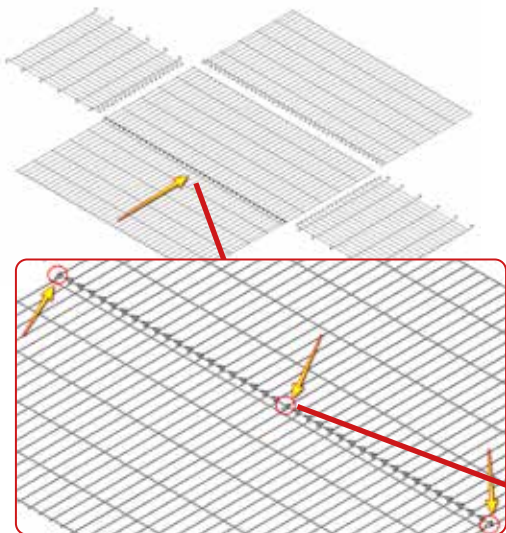

1. Dopo aver posizionato base e lati vicini, è sufficiente stringere con un martello o una pinza almeno 3 ganci dei lati attorno ai bordi della base.

After placing the base and sides close together, it is sufficient to tighten with a hammer or pliers at least 3 hooks of the sides around the side of the base.

Nachdem Sie die Seitenteile am Bodenelement eingehakt haben, müssen Sie mindestens 3 Schlaufen mit einem Hammer oder einer Zange umbiegen.

Après avoir placé la base et rapproché les côtés, Serrez avec un marteau ou une pince, au moins 3 crochets sur les côtés autour des bords de la base.

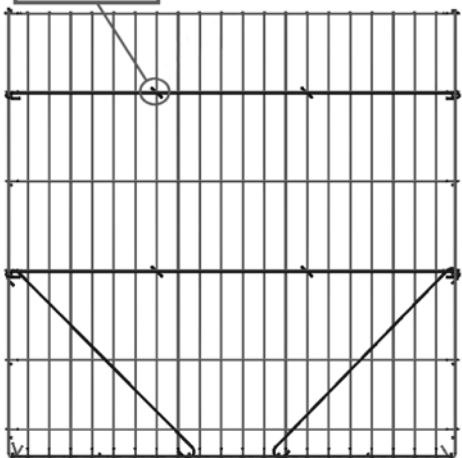
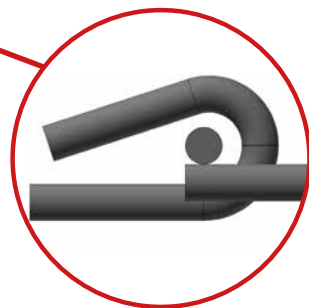

3. I tiranti lunghi devono stare al di sopra di quelli corti.

Long ties must stand above short ties.

Die langen müssen über den kurzen Stangen liegen.

Les tirants longs doivent être au-dessus des tirants courts.

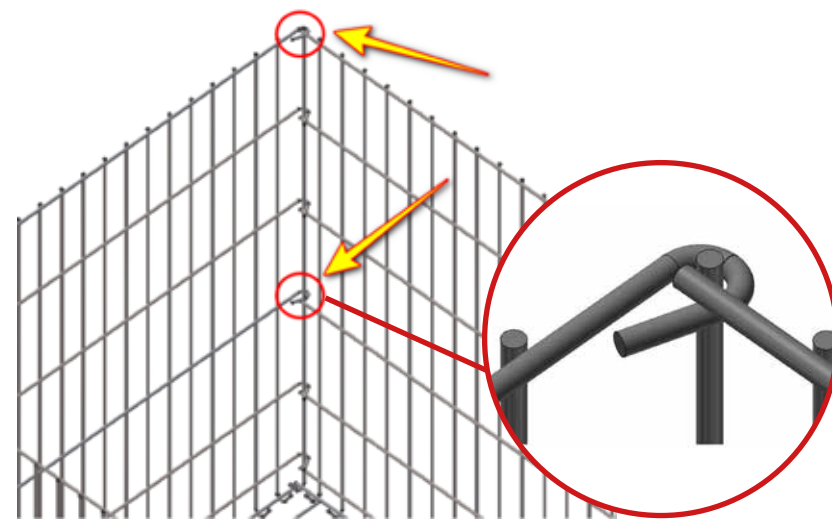

2. Per agganciare tra loro i lati è sufficiente chiudere il primo gancio e quello centrale di ogni bordo.

To hook the sides together, simply close the first hook and the central one of each edge.

Um die Ecken mit einander zu verbinden müssen Sie den obersten und mittlersten Haken umbiegen.

Pour bien fixer l'ensemble des côtés, fermez simplement le premier crochet et le crochet central de chaque bord.

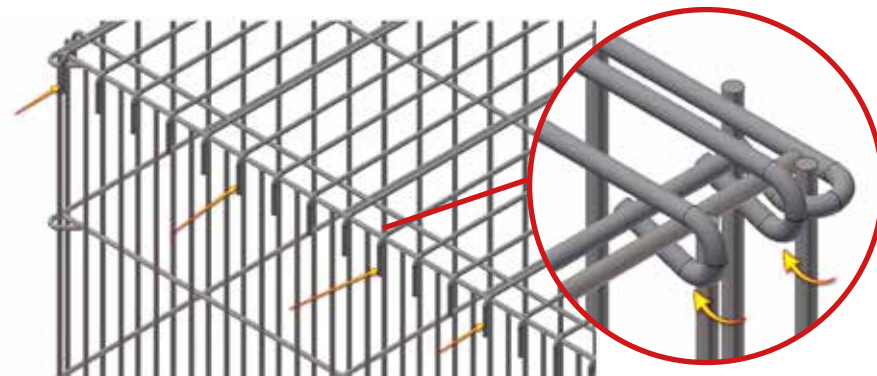

4. Posizionato il coperchio, chiudere tutti i ganci verso l'interno del gabbione.

Once the lid has been placed, close all the hooks towards the inside of the gabbione.

Nach dem aufsetzen des Deckels müssen alle Haken nach innen gebogen werden.

Une fois le couvercle posé, fermez tous les crochets vers l'intérieur du gabbion.



Natural Stone Box è un prodotto di Granulati Zandobbio S.p.A.

Natural Stone Box is a product by Granulati Zandobbio S.p.A.
Natural Stone Box ist ein Produkt von Granulati Zandobbio S.p.A.
Natural Stone Box est un produit de Granulati Zandobbio S.p.A.

